

Zeta Push Button Temporary Fire Alarm (PBTA-200)

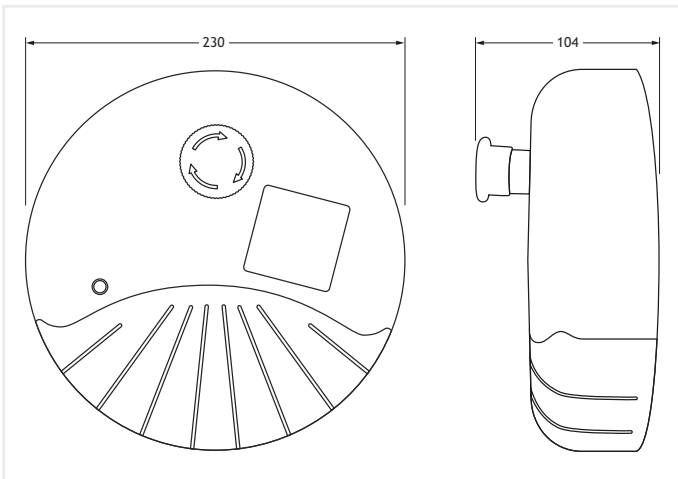

The PBTA-200 push button temporary fire alarm is activated immediately by pressing the “mushroom” button fixed to the front of the device. Once activated the unit will sound & flash.

It can be used as a standalone alarm or interconnected in series.



Features

- ✓ Standalone or interconnected fire alarm system
- ✓ 95dB @ 3m & flashing strobe alarm
- ✓ Interconnect up to 32 units in series

Model	PBTA-200
Operating Voltage	8 x AA batteries (12V DC)
Average Current	10uA
Alarm Current	200mA
Sound Output	95 db @ 3m
Strobe Colour	Red
Operating Temperature	-10°C to +50°C
Minimum Continuous Temperature	0°C
Maximum Humidity	95% RH Non Condensing
Alarm Activation	Manual (press “mushroom” button)
Reset	Manual (twist “mushroom” button)
Number of Interlinked Units	32
IP Rating	IP35
Size, Width x Height x Diameter	230mm x 230mm x 104mm
Weight (Including Batteries)	650g (850g)